

Before installation download the complete manual and read all instruction.

Bevor Sie mit der Montage anfangen, laden Sie bitte komplette Montageanleitung herunter und lesen Sie sorgfältig durch.

Avant de commencer l'installation, télécharger le manuel complet et le lire attentivement.

Před začátkem montáže si stáhněte kompletní manuál a důkladně jej prostudujte.

<http://door-documents.com/en/installation-manual-industrial-door-hl-t>



**1**

2" = 81  
3" = 95

2" = W+162  
3" = W+190

5x

Y

5x

H

a = b

b

a

C-PROFIL

1.1

1.2

1.3

1.4

F1

**2**

2.1

2.2

M

2.3

Max 18 Nm

H

Y

2.4

2x

A

F

2x

2.5

F

C-PROFIL

Y

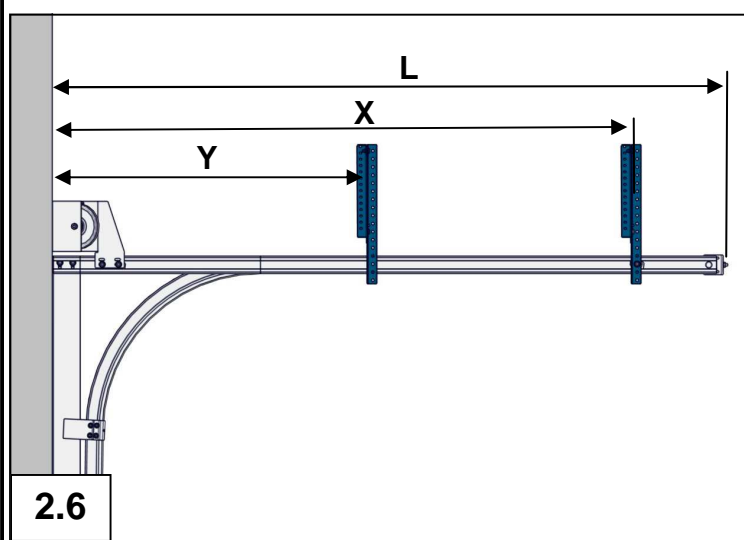

L ≤ 3000 mm	
X	X = H - HL
L > 3000 mm	
X	X = H - HL
Y	Y = 1/2 X

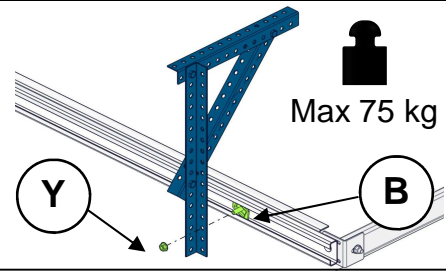

2.7

Max 18 Nm

Y

B

2.8

F1

2.9

Max 18 Nm

Y

2x

2x

B

**3**

3.1

R

L

R

L

3.2

a

b

a = b

3.3

H

2x

Y

**4**

4.1

Max 10 Nm

L = 16 mm

Max 10 Nm

L = 16 mm

Max 10 Nm

L = 16 mm

Max 10 Nm

L = 16 mm

Max 10 Nm

L = 16 mm

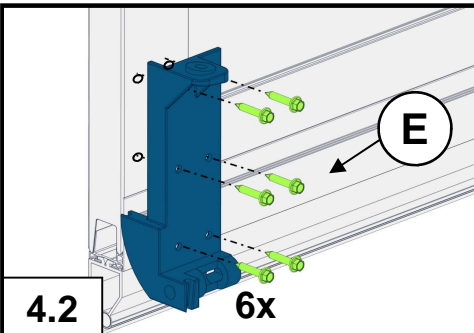
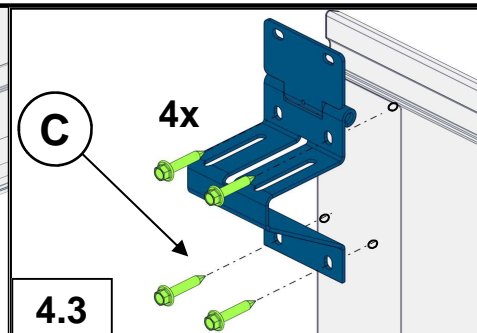
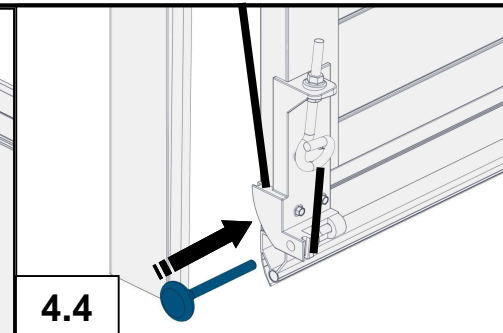
**4.2**  **4.3**  **4.4** 

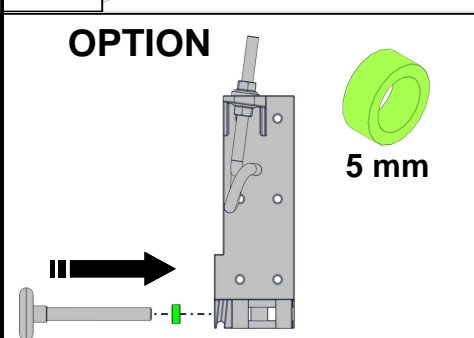
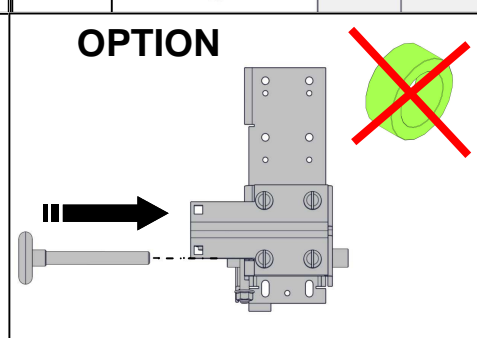
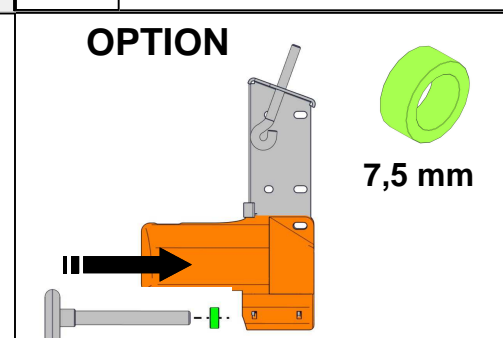
**OPTION**  **OPTION**  **OPTION** 

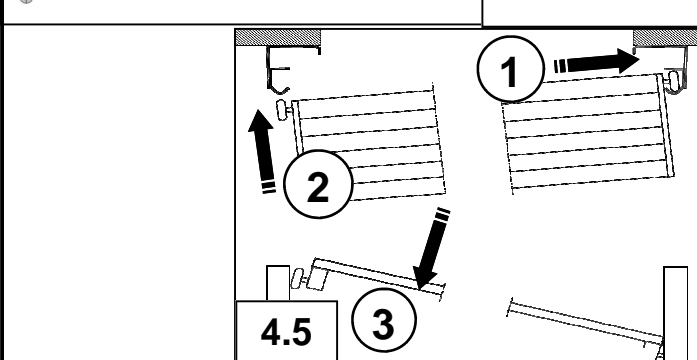
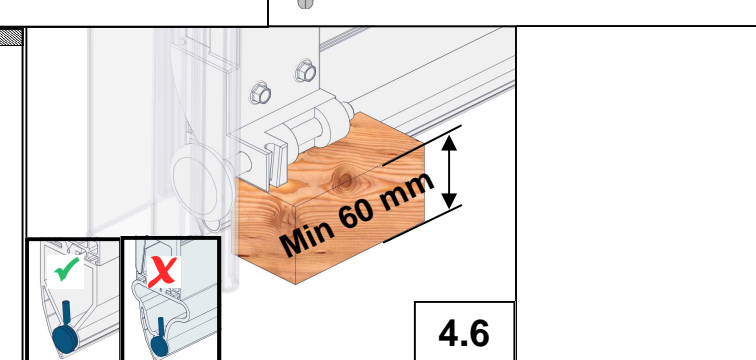
**4.5**  **4.6** 

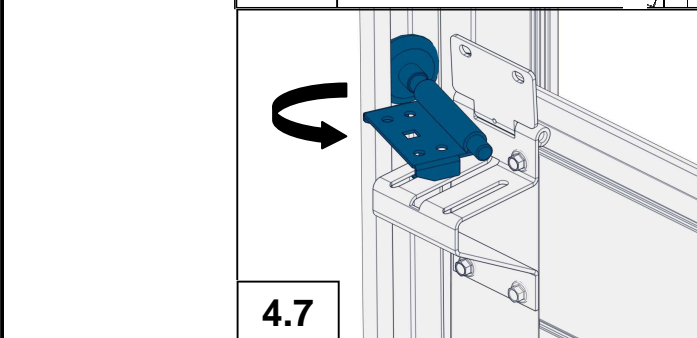
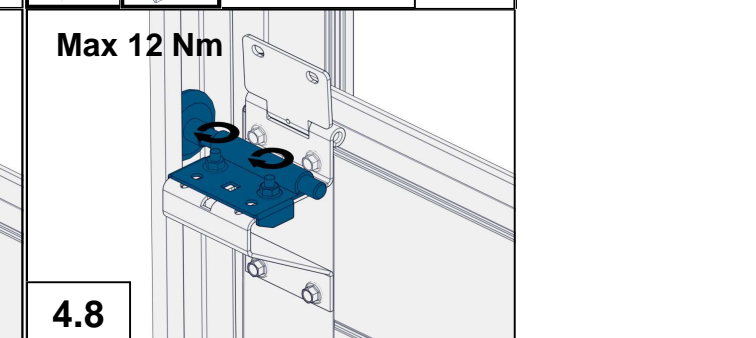

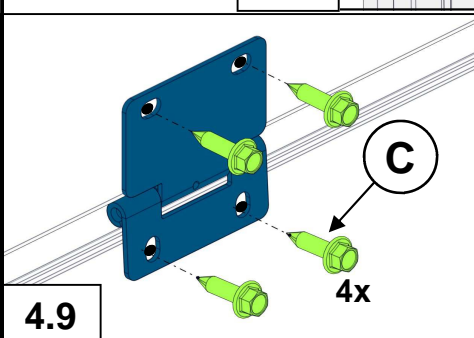
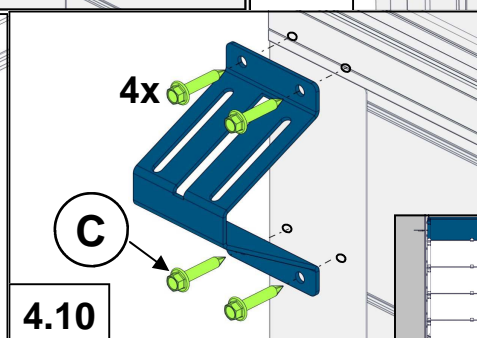
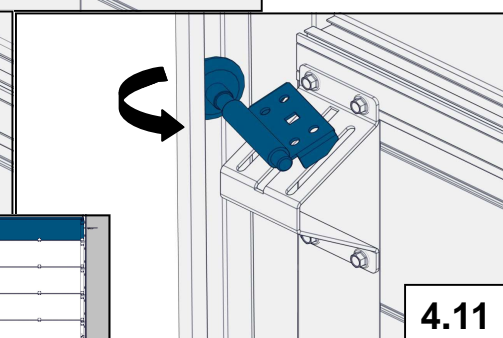
**4.7**  **4.8** 

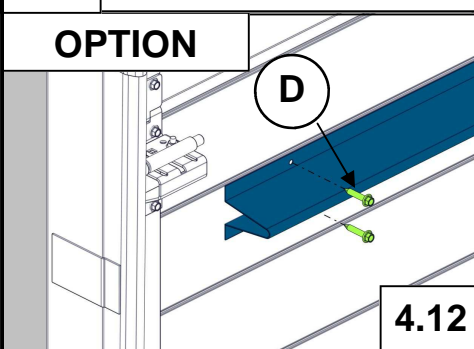
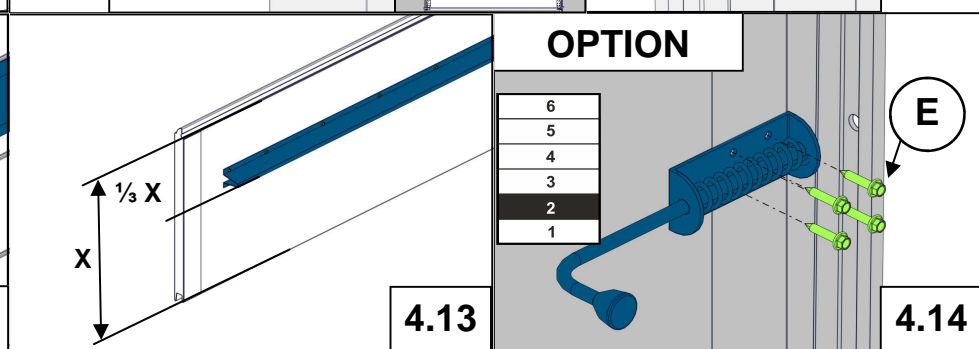
**4.9**  **4.10**  **4.11** 

**OPTION**  **OPTION** 

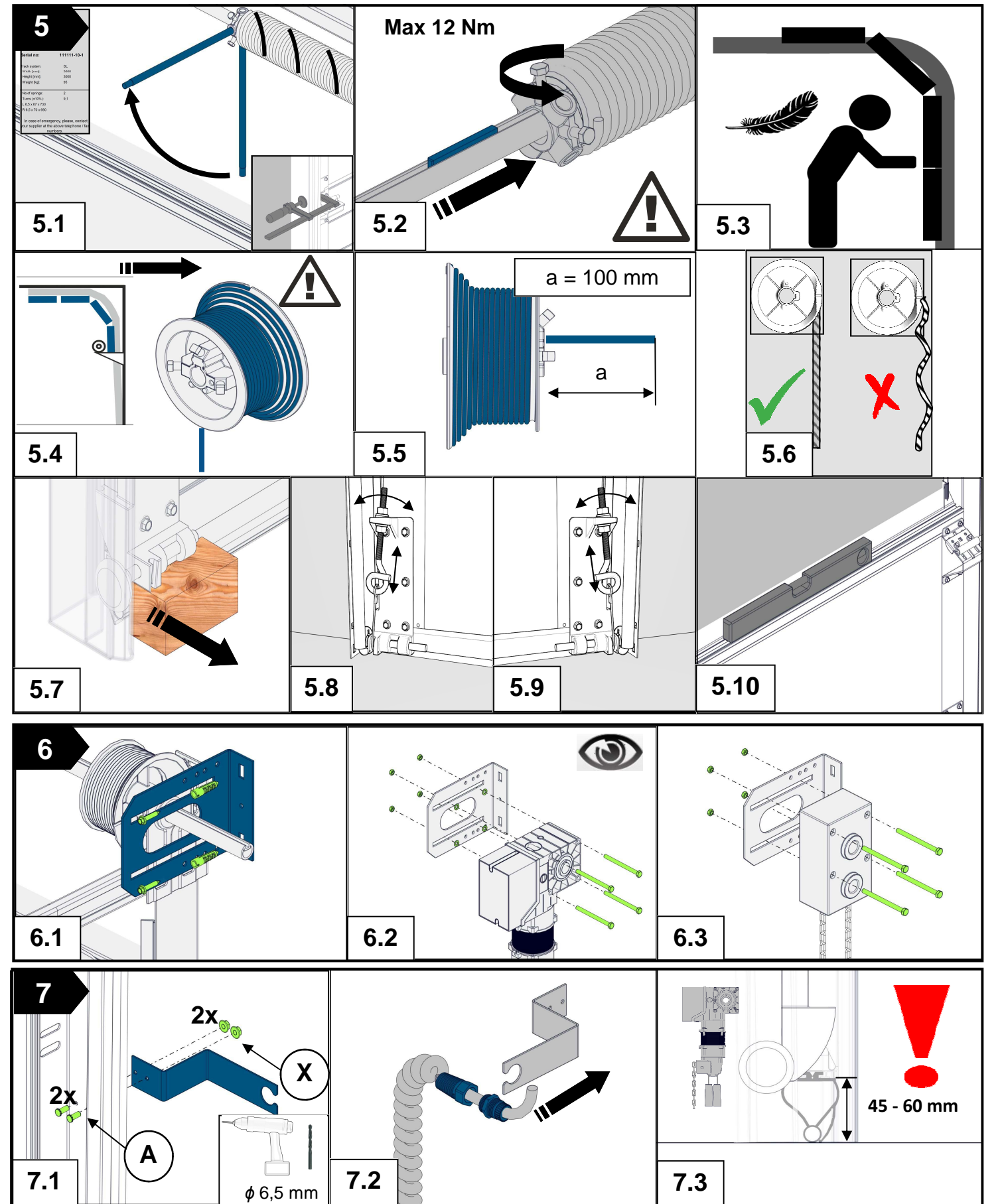
6
5
4
3
2
1

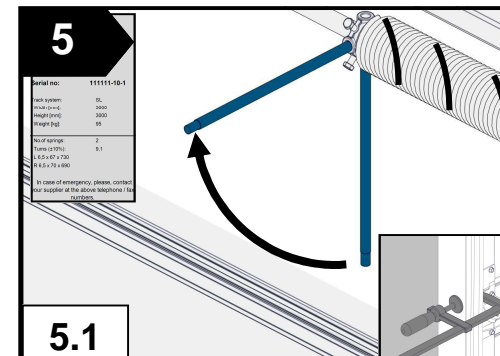
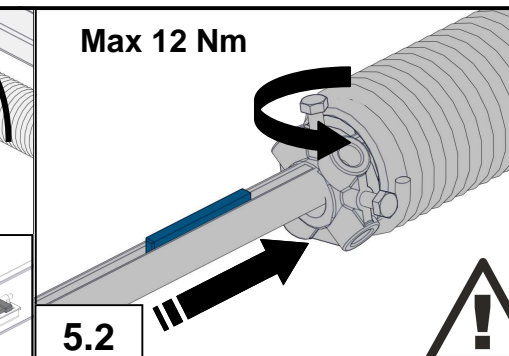
**5** 

**5.1**  **5.2**  **5.3** 

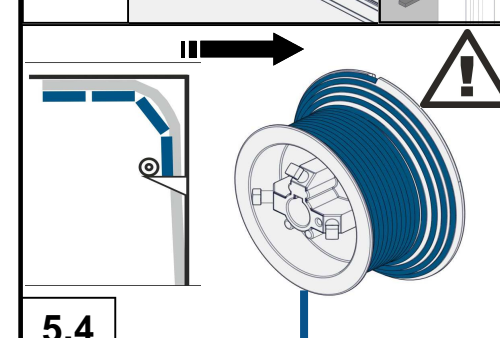
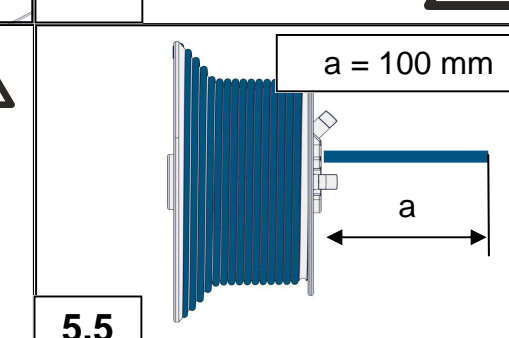
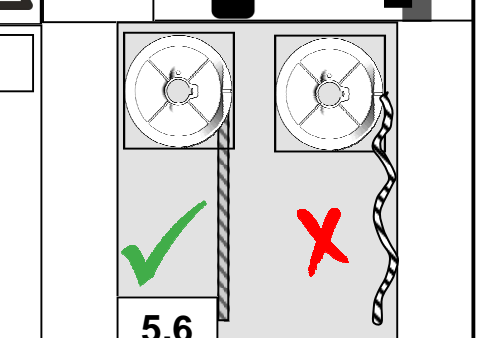
**5.4**  **5.5**  **5.6** 

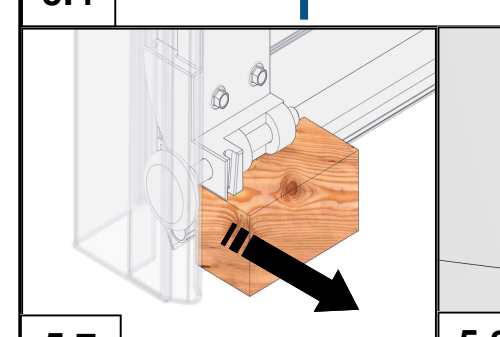
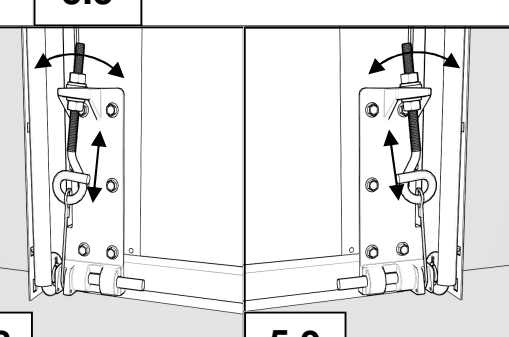
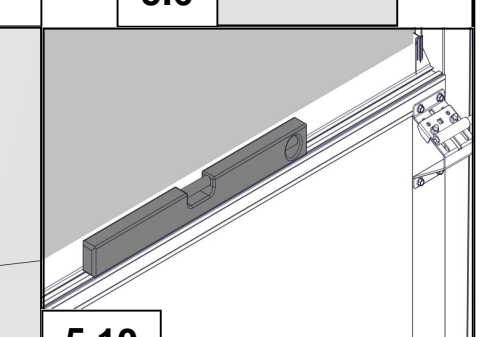
**5.7**  **5.8**  **5.9**  **5.10** 

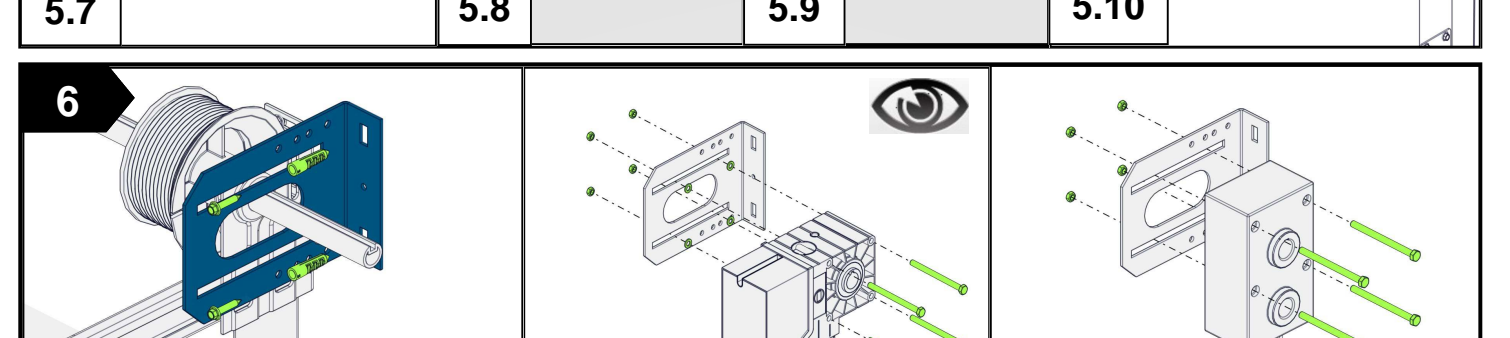
**6** 

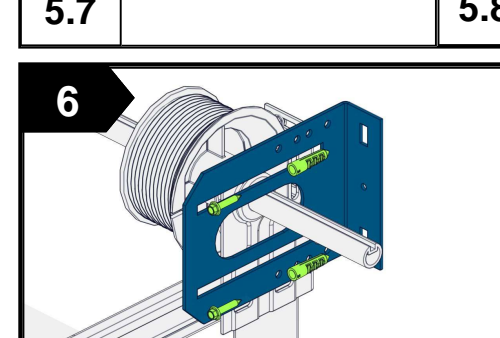
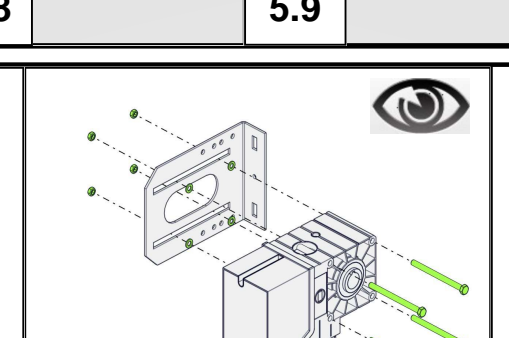
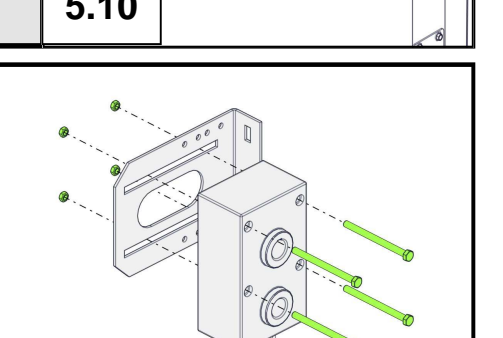
**6.1**  **6.2**  **6.3** 

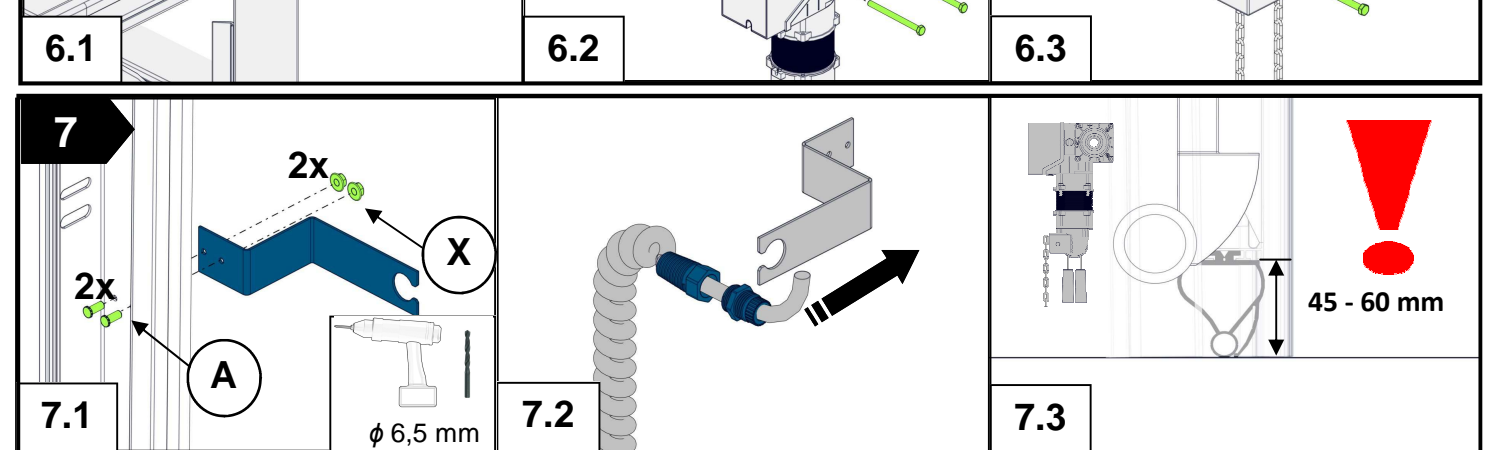
**7** 

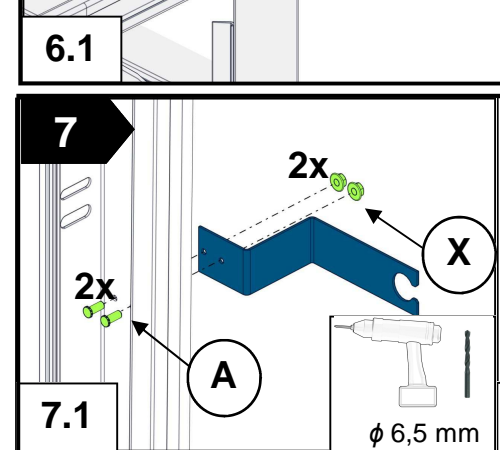
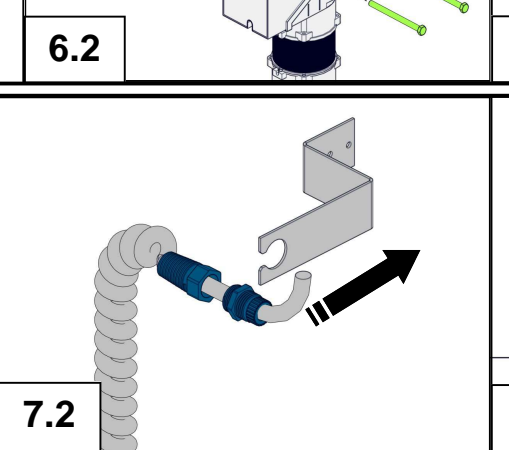
**7.1**  **7.2**  **7.3** 